

FEATURES

ALGOOD

- KINGPIN:** 5/8" diameter nut and bolt coined
- RACEWAY:** 5/16" diameter upper race; 1/4" diameter lower race; hardened steel load bearings
- BUSHING:** Roller bearings with drilled hardened steel spanner bushing and plastic side washers
- AXLE&NUT:** 1/2" zerk axle and lock nut (except with PB)
- FINISH:** Corrosion resistant bright zinc
- LUBRICATION:** Grease nipple in lower race
- HARDENED:** Work hardened double ball race
- LEG SPACING:** 2 1/2"

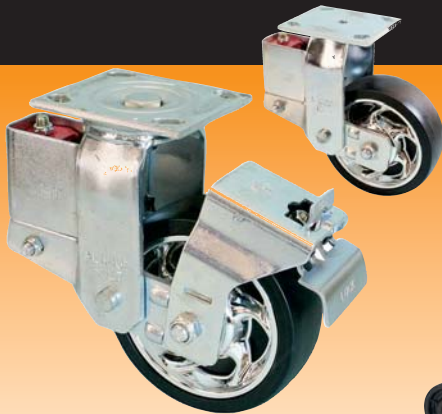

EXCELLENT FOR

- Mobile motion picture staging
- Aircraft ground support equipment
- In-plant trailer parts
- Trash containers
- Tool carts
- Amusement parks
- Asphalt paving machinery
- Material handling equipment

OPTIONS

- AWL** A Lock Wheel Brake (for 6" only)
- UWB** Universal Wheel Brake
- 1PSL** 1 Position Swivel Lock
- 2PSL** 2 Position Swivel Lock
- 3PSL** 3 Position Swivel Lock
- 4PSL** 4 Position Swivel Lock
- BB** Ball Bearing
- BR** Bronze Bearing
- DB** Delrin Bearing
- NB** Nylon Roller Bearing
- PB** Precision Ball Bearing
- RBC** Caged Roller Bearing
- C** Raceway Seal
- OH** Special Overall Height
- SSW** Steel Side Washer
- SWH** Heat-treated Side Washer
- TG** Thread Guards
- Z** Zerk in Wheel

FINISHES

- SL70?2 Chrome
- SL70?4 Black
- Inquiries on other finishes welcome



WHEEL			CASTER			PART NUMBER					
Diameter	Tread Width	Capacity Lbs.	Bearing Type	Swivel Radius	Overall Height	Wheel Type	Swivel	Caster Weight (lbs)	Rigid	Caster Weight (lbs)	
5"	2"	350	Ball	4 13/16"	8"	Alum. Rubber Grey	SSL7063-***-5ARG-BB-Δ	9.43	RSL7063-***-5ARG-BB-Δ	8.58	
		350	Roller			Soft Rubber	SSL7063-***-5SR-RB-Δ	9.25	RSL7063-***-5SR-RB-Δ	8.40	
		375	Roller			ProTech™ Crown	SSL7063-***-5PRO-RB-Δ	8.46	RSL7063-***-5PRO-RB-Δ	7.61	
		450	Roller			Moldon Rubber	SSL7063-***-5MR-RB-Δ	10.14	RSL7063-***-5MR-RB-Δ	9.29	
		500	Roller			Moldon Alum. Rubber	SSL7063-***-5MAR-RB-Δ	8.92	RSL7063-***-5MAR-RB-Δ	8.07	
		650	Roller			Polyolefin	SSL7063-***-5POX-RB-Δ	7.97	RSL7063-***-5POX-RB-Δ	7.12	
		750	Roller			High Temp Phenolic (475°)	SSL7063-***-5HTPH-RB-Δ	9.02	RSL7063-***-5HTPH-RB-Δ	8.17	
		800	Roller			Lava™	SSL7063-***-5LV-RB-Δ	8.32	RSL7063-***-5LV-RB-Δ	7.47	
		800	Roller			Envirothane™	SSL7063-***-5U-RB-Δ	8.72	RSL7063-***-5U-RB-Δ	7.87	
		800	Precision			Envirothane™ Grey - PB	SSL7063-***-5UG-PB-Δ	8.78	RSL7063-***-5UG-PB-Δ	7.93	
		800	Roller			Envirothane™ Grey - RB	SSL7063-***-5UG-RB-Δ	8.72	RSL7063-***-5UG-RB-Δ	7.87	
		900	Roller			Moldon Alum. Urethane	SSL7063-***-5MAU-RB-Δ	8.82	RSL7063-***-5MAU-RB-Δ	7.97	
		900	Roller			Moldon Poly. Urethane	SSL7063-***-5MPU-RB-Δ	8.70	RSL7063-***-5MPU-RB-Δ	7.85	
		950	Roller			ALThane™	SSL7063-***-5ALT-RB-Δ	8.32	RSL7063-***-5ALT-RB-Δ	7.47	
		1,000	Roller			Ductile Iron Crowned	SSL7063-***-5DIC-RB-Δ	11.54	RSL7063-***-5DIC-RB-Δ	10.69	
		1,000	Roller			Heavy Duty Lava™	SSL7063-***-5LVHD-RB-Δ	8.63	RSL7063-***-5LVHD-RB-Δ	7.78	
		1,000	Roller			Nyroll™	SSL7063-***-5NYN-RB-Δ	8.56	RSL7063-***-5NYN-RB-Δ	7.71	
		1,000	Roller			Phenolic	SSL7063-***-5PH-RB-Δ	8.92	RSL7063-***-5PH-RB-Δ	8.07	
		1,000	Roller			RollIX™	SSL7063-***-5RX-RB-Δ	8.26	RSL7063-***-5RX-RB-Δ	7.41	
		1,000	Roller			Heavy Duty RollIX™	SSL7063-***-5RXHD-RB-Δ	8.58	RSL7063-***-5RXHD-RB-Δ	7.73	
1,000	Roller	Solid Steel	SSL7063-***-5SS-RB-Δ	10.96	RSL7063-***-5SS-RB-Δ	10.11					
1,000	Roller	Moldon Urethane	SSL7063-***-5UR-RB-Δ	10.76	RSL7063-***-5UR-RB-Δ	9.91					
1,000	Roller	V Groove	SSL7063-***-5VG-RB-Δ	11.98	RSL7063-***-5VG-RB-Δ	11.13					

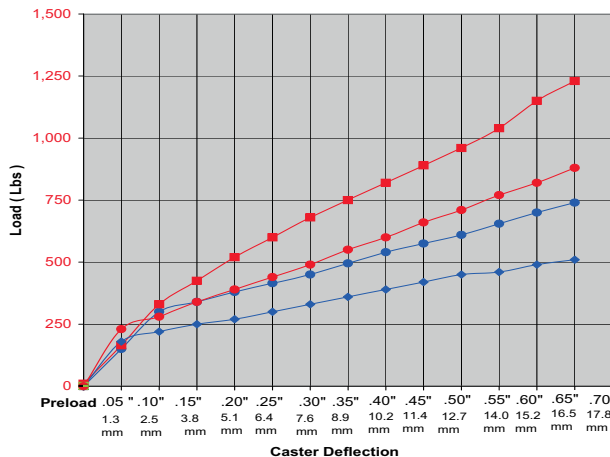

SL7003 SERIES

ALGOOD

PLATE DIAGRAMS

Standard Plate: A38H

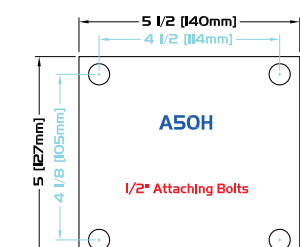
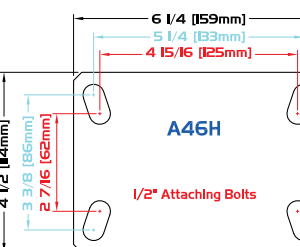
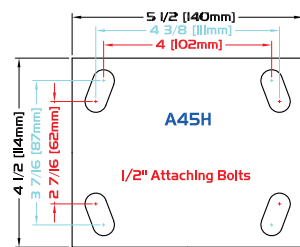
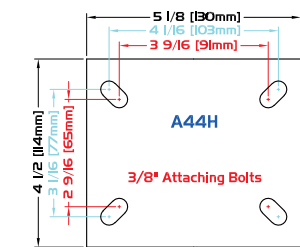
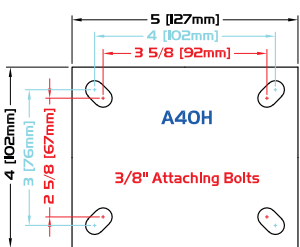
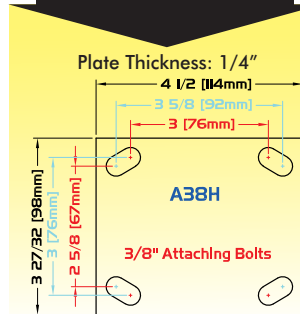

WHEEL			CASTER			PART NUMBER				
Diameter	Tread Width	Capacity Lbs.	Bearing Type	Swivel Radius	Overall Height	Wheel Type	Swivel	Caster Weight (lbs)	Rigid	Caster Weight (lbs)
6"	2"	250	Ball	5 5/16"	8 1/2"	Pneumatic Foam	SSL7063-***-PFC-BB-Δ	7.98	RSL7063-***-PFC-BB-Δ	7.13
		250	Ball			Pneumatic Foam Grey	SSL7063-***-PFCG-BB-Δ	7.98	RSL7063-***-PFCG-BB-Δ	7.13
		275	Ball			Pneumatic	SSL7063-***-PNC-BB-Δ	8.89	RSL7063-***-PNC-BB-Δ	8.04
		275	Ball			Pneumatic Grey	SSL7063-***-PNCG-BB-Δ	8.89	RSL7063-***-PNCG-BB-Δ	8.04
		450	Ball			Balloon Cushion Rubber Grey	SSL7063-***-BARG-BB-Δ	9.77	RSL7063-***-BARG-BB-Δ	8.92
		450	Roller			ProTech™ Crown	SSL7063-***-PRO-RB-Δ	8.76	RSL7063-***-PRO-RB-Δ	7.91
		500	Roller			Moldon Alum. Rubber	SSL7063-***-MAR-RB-Δ	9.44	RSL7063-***-MAR-RB-Δ	8.59
		500	Roller			Moldon Rubber	SSL7063-***-MR-RB-Δ	11.12	RSL7063-***-MR-RB-Δ	10.27
		500	Roller			ProTech™ Flat	SSL7063-***-PROF-RB-Δ	8.76	RSL7063-***-PROF-RB-Δ	7.91
		700	Roller			Polyolefin	SSL7063-***-POX-RB-Δ	8.13	RSL7063-***-POX-RB-Δ	7.28
		900	Roller			High Temp Phenolic (475°)	SSL7063-***-HTPH-RB-Δ	9.82	RSL7063-***-HTPH-RB-Δ	8.97
		900	Roller			Moldon Poly. Urethane	SSL7063-***-MPU-RB-Δ	9.22	RSL7063-***-MPU-RB-Δ	8.37
		950	Roller			Envirothane™	SSL7063-***-U-RB-Δ	9.40	RSL7063-***-U-RB-Δ	8.55
		950	Precision			Envirothane™ Grey - PB	SSL7063-***-UG-PB-Δ	9.17	RSL7063-***-UG-PB-Δ	8.32
		950	Roller			Envirothane™ Grey - RB	SSL7063-***-UG-RB-Δ	9.40	RSL7063-***-UG-RB-Δ	8.55
		950	Precision			Envirothane™ Grey Crowned	SSL7063-***-UGC-PB-Δ	9.12	RSL7063-***-UGC-PB-Δ	8.27
		1,000	Roller			ALThane™	SSL7063-***-ALT-RB-Δ	8.87	RSL7063-***-ALT-RB-Δ	8.02
		1,000	Roller			Ductile Iron Crowned	SSL7063-***-DIC-RB-Δ	12.56	RSL7063-***-DIC-RB-Δ	11.71
		1,000	Roller			Lava™	SSL7063-***-LV-RB-Δ	8.53	RSL7063-***-LV-RB-Δ	7.68
		1,000	Roller			Heavy Duty Lava™	SSL7063-***-LVHD-RB-Δ	9.04	RSL7063-***-LVHD-RB-Δ	8.19
1,000	Roller	Moldon Alum. Urethane	SSL7063-***-MAU-RB-Δ	9.40	RSL7063-***-MAU-RB-Δ	8.55				
1,000	Roller	Nyroll™	SSL7063-***-NYN-RB-Δ	9.03	RSL7063-***-NYN-RB-Δ	8.18				
1,000	Roller	Phenolic	SSL7063-***-PH-RB-Δ	9.72	RSL7063-***-PH-RB-Δ	8.87				
1,000	Roller	RollX™	SSL7063-***-RX-RB-Δ	8.48	RSL7063-***-RX-RB-Δ	7.63				
1,000	Roller	Heavy Duty RollX™	SSL7063-***-RXHD-RB-Δ	9.00	RSL7063-***-RXHD-RB-Δ	8.15				
1,000	Roller	Solid Steel	SSL7063-***-SS-RB-Δ	12.10	RSL7063-***-SS-RB-Δ	11.25				
1,000	Roller	Moldon Urethane	SSL7063-***-UR-RB-Δ	11.58	RSL7063-***-UR-RB-Δ	10.73				
1,000	Roller	V Groove	SSL7063-***-VG-RB-Δ	13.22	RSL7063-***-VG-RB-Δ	12.37				
8"	2"	550	Ball	6 7/8"	10 1/2"	Balloon Cushion Rubber Grey	SSL7083-***-BARG-BB-Δ	11.89	RSL7083-***-BARG-BB-Δ	11.04
		600	Roller			Moldon Alum. Rubber	SSL7083-***-MAR-RB-Δ	10.88	RSL7083-***-MAR-RB-Δ	10.03
		600	Roller			Moldon Rubber	SSL7083-***-MR-RB-Δ	13.50	RSL7083-***-MR-RB-Δ	12.65
		600	Roller			ProTech™ Crown	SSL7083-***-PRO-RB-Δ	10.19	RSL7083-***-PRO-RB-Δ	9.34
		650	Roller			ProTech™ Flat	SSL7083-***-PROF-RB-Δ	10.15	RSL7083-***-PROF-RB-Δ	9.30
		850	Roller			ALThane™	SSL7083-***-ALT-RB-Δ	10.02	RSL7083-***-ALT-RB-Δ	9.17
		850	Roller			High Temp Phenolic (475°)	SSL7083-***-HTPH-RB-Δ	11.72	RSL7083-***-HTPH-RB-Δ	10.87
		850	Roller			Lava™	SSL7083-***-LV-RB-Δ	9.91	RSL7083-***-LV-RB-Δ	9.06
		850	Roller			Moldon Alum. Urethane	SSL7083-***-MAU-RB-Δ	11.06	RSL7083-***-MAU-RB-Δ	10.21
		850	Roller			Moldon Poly. Urethane	SSL7083-***-MPU-RB-Δ	10.34	RSL7083-***-MPU-RB-Δ	9.49
		850	Roller			Nyroll™	SSL7083-***-NYN-RB-Δ	10.47	RSL7083-***-NYN-RB-Δ	9.62
		850	Roller			Phenolic	SSL7083-***-PH-RB-Δ	11.62	RSL7083-***-PH-RB-Δ	10.77
		850	Roller			Polyolefin	SSL7083-***-POX-RB-Δ	9.17	RSL7083-***-POX-RB-Δ	8.32
		850	Roller			RollX™	SSL7083-***-RX-RB-Δ	9.86	RSL7083-***-RX-RB-Δ	9.01
		850	Roller			Solid Steel	SSL7083-***-SS-RB-Δ	15.06	RSL7083-***-SS-RB-Δ	14.21
		850	Roller			Semi Steel	SSL7083-***-ST-RB-Δ	15.06	RSL7083-***-ST-RB-Δ	14.21
		850	Roller			Envirothane™	SSL7083-***-U-RB-Δ	10.96	RSL7083-***-U-RB-Δ	10.11
		850	Precision			Envirothane™ Grey - PB	SSL7083-***-UG-PB-Δ	10.84	RSL7083-***-UG-PB-Δ	9.99
		850	Roller			Envirothane™ Grey - RB	SSL7083-***-UG-RB-Δ	10.96	RSL7083-***-UG-RB-Δ	10.11
		850	Precision			Envirothane™ Grey Crowned	SSL7083-***-UGC-PB-Δ	10.90	RSL7083-***-UGC-PB-Δ	10.05
850	Roller	Moldon Urethane	SSL7083-***-UR-RB-Δ	14.22	RSL7083-***-UR-RB-Δ	13.37				
850	Roller	V Groove	SSL7083-***-VG-RB-Δ	17.02	RSL7083-***-VG-RB-Δ	16.17				

STEMS

THREADED STEMS			
***	DIAMETER	LENGTH	TYPE
1/2-13X4HO	1/2"	4"	NC
5/8-11X4	5/8"	4"	NC
3/4-10X4	3/4"	4"	NC
7/8-9X4	7/8"	4"	NC
1-8X4	1"	4"	NC



Threaded Stem

ROUND STEMS			
***	DIAMETER	LENGTH	TYPE
500 X 4	1/2"	4"	Plain
625 X 4	5/8"	4"	Plain
750 X 4	3/4"	4"	Plain
875 X 4	7/8"	4"	Plain
1,000 X 4	1"	4"	Plain
1,375 X 4	1 3/8"	4"	Plain



Round Stem



* Caster weight based on Standard Plate